







KERBL Pet

#82410

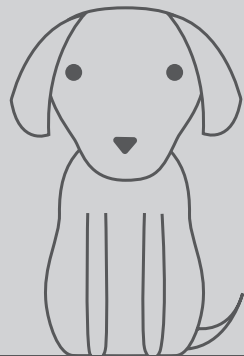
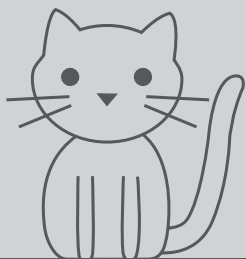
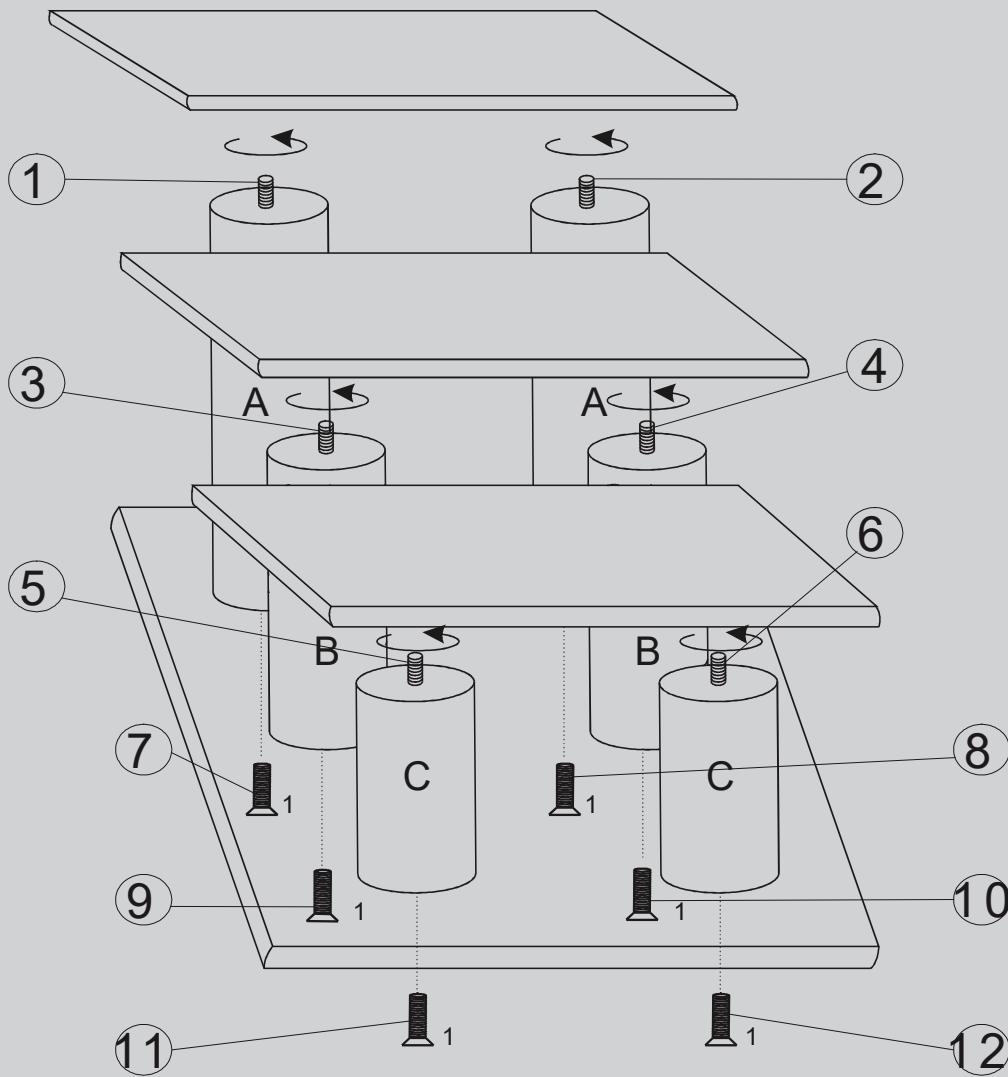

- | | | | | |
|--|--|---|---|---|
| 1

m8*50mm
6 PCS | 2

1 PC | A

D10*30cm
2 PCS | B

D10*20cm
2 PCS | C

D10*10cm
2 PCS |
|--|--|---|---|---|



Albert Kerbl GmbH
Felizenzell 9
84428 Buchbach, Germany
Tel. +49 8086 933 - 100
Fax +49 8086 933 - 500
E-Mail info@kerbl.de
www.kerbl.de

Kerbl Austria Handels GmbH
Wirtschaftspark 1
9130 Poggersdorf
Tel. +43 4224 81555
Fax. +43 4224 81555-629
E-Mail order@kerbl-austria.at
www.kerbl-austria.at

Kerbl France Sarl
3 rue Henri Rouby, B.P 46 Soultz
68501 Guebwiller Cedex, France
Tel. +33 3 89 62 15 00
Fax +33 3 89 83 04 46
E-Mail info@kerbl-france.com
www.kerbl-france.com

Kerbl UK Limited
8 Lands End Way
Oakham, Rutland
LE15 6RF UK
Phone +44 01572 722558
Fax +44 01572 757614
E-Mail enquiries@kerbl.co.uk
www.kerbl.co.uk