









1	2	3	4	A	B
					
M8*40mm 1PC	M8*85mm 1PC	2PCS	1PC	D7*20CM 2PCS	D7*26CM 1PC

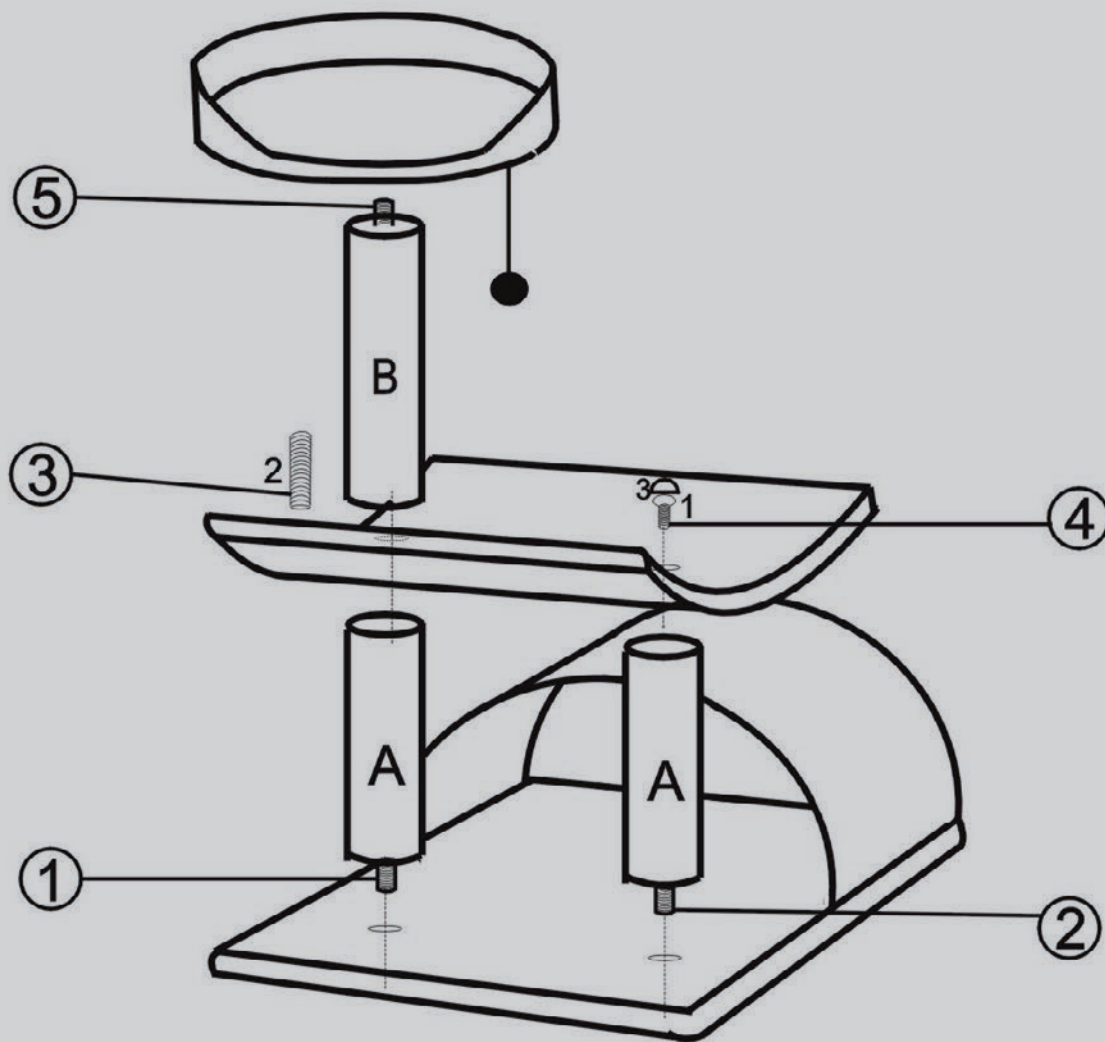

(DE) Bitte halten Sie die Reihenfolge der Arbeitsschritte 1,2,3,... von der Skizze ein.

(FR) Veuillez suivre la sequence du Workflow 1, 2, 3 ...comme vous pouvez le voir sur le schema.

(EN) Pls follow the sequence of the workflow 1,2,3,... as you can see on the draft.