









|   |   |   |   |   |   |
|---|---|---|---|---|---|
| <b>1</b>  | <b>2</b>  | <b>3</b>  | <b>A</b>  | <b>B</b>  | <b>C</b>  |
|  |  |  |  |  |  |
| M8*50<br>4 PCS  | M8*50<br>2 PCS  | 1PCS  | D8*20CM<br>1 PCS  | D8*30CM<br>1 PCS  | D8*40CM<br>2PCS   |

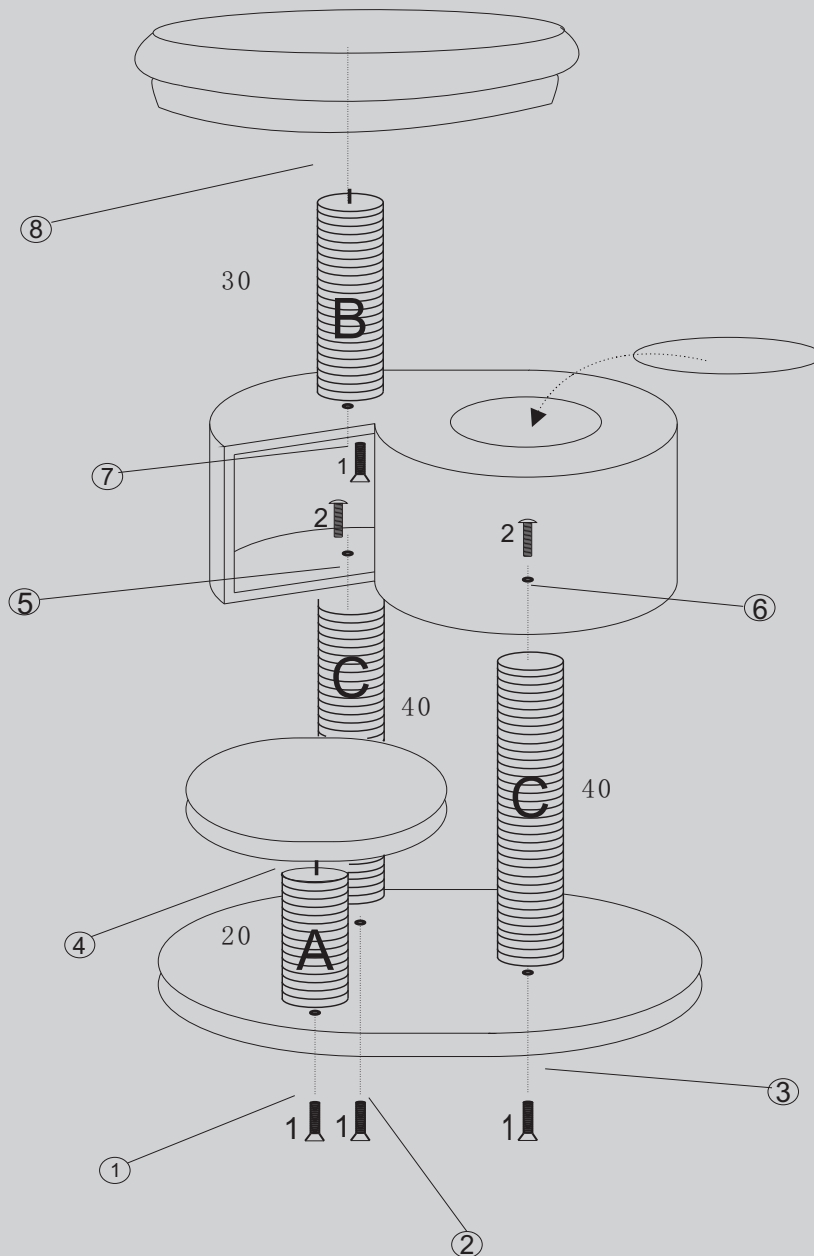

(DE) Bitte halten Sie die Reihenfolge der Arbeitsschritte 1,2,3,... von der Skizze ein.

(FR) Veuillez suivre la sequence du Workflow 1, 2, 3 ...comme vous pouvez le voir sur le schema.

(EN) Pls follow the sequence of the workflow 1,2,3,... as you can see on the draft.