













# KERBL Pet

#81566



									
M8*16mm 4 PCS	M8*35mm 2 PCS	M8*50mm 10 PCS	M8*60mm 1 PC	M8*80mm 3 PCS	1 PC	D8,5*36cm 3PCS	D8,5*40cm 1 PC	D8,5*40cm 1 PC	D8,5*50cm 4 PCS

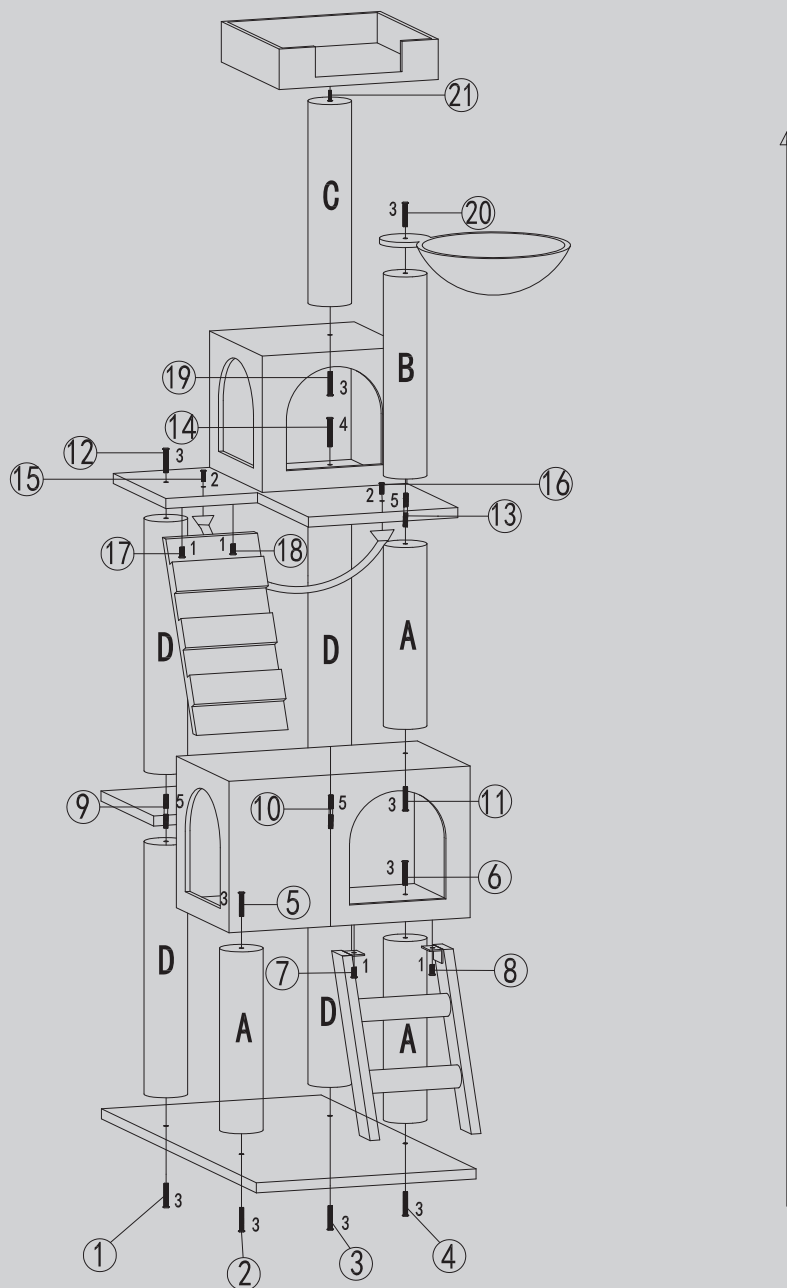

(DE) Bitte halten Sie die Reihenfolge der Arbeitsschritte 1,2,3,... von der Skizze ein.

(FR) Veuillez suivre la sequence du Workflow 1, 2, 3 ...comme vous pouvez le voir sur le schema.

(EN) Pls follow the sequence of the workflow 1,2,3,... as you can see on the draft.

Albert Kerbl GmbH  
Felizenzell 9  
84428 Buchbach, Germany  
Tel. +49 8086 933 - 100  
Fax +49 8086 933 - 500  
E-Mail info@kerbl.de  
www.kerbl.de

Kerbl Austria Handels GmbH  
Wirtschaftspark 1  
9130 Poggersdorf  
Tel. +43 4224 81555  
Fax. +43 4224 81555-629  
E-Mail order@kerbl-austria.at  
www.kerbl-austria.at

Kerbl France Sarl  
3 rue Henri Rouby, B.P 46 Soultz  
68501 Guebwiller Cedex, France  
Tel. +33 3 89 62 15 00  
Fax +33 3 89 83 04 46  
E-Mail info@kerbl-france.com  
www.kerbl-france.com

Kerbl UK Limited  
8 Lands End Way  
Oakham, Rutland  
LE15 6RF UK  
Phone +44 01572 722558  
Fax +44 01572 757614  
E-Mail enquiries@kerbl.co.uk  
www.kerbl.co.uk